

# The LC-MS/MS workhorse

SCIEX 4500 Series mass spectrometers





The SCIEX 4500 Series of mass spectrometers takes the legendary API 4000™ LC-MS/MS system and intelligently re-engineers it to set a new benchmark for reliable quantitation. It offers the quantitative sensitivity, robustness, and performance you need, powered with QTRAP® technology to open a world of valuable experiments beyond MRM for significant data quality improvements for your most challenging methods.

Whether your research is focused on ADME, regulated bioanalysis, food and environmental contaminant screening, targeted quantitative proteomics, or clinical research, the SCIEX 4500 Series covers your key performance criteria:

- Quantitative and qualitative sensitivity to detect low concentration analytes in challenging matrices
- Dynamic range to see low to high concentration levels
- Scan speed to clearly resolve similar analytes
- Ionization source flow range for liquid chromatography flexibility
- Uniquely designed to occupy less of your valuable lab space

**All backed by the integrity and quality of the SCIEX brand.**

# SCIEX 4500 Series

## The LC-MS/MS workhorse, intelligently re-engineered.

**Redesigned from the foundation of our industry standard triple quadrupole mass spectrometers, the 4500 Series introduces a new era of LC-MS/MS performance defined by fast, precise quantitation and ultra-fast scan speeds. The system is ideal for UHPLC, and with available QTRAP® technology you get better data, and more of it, than you can achieve using basic multiple reaction monitoring (MRM) on an ordinary triple quad system.**

### **Fast LC demands short dwell times**

Delivering dwell times as low as 1ms, the 4500 complements UHPLC separations to screen for more compounds within a single experiment than ever before. You can maximize your capacity and deliver quality quantitation every time using the powerful *Scheduled* MRM™ algorithm which automatically optimizes your acquisition method.

### **Better data. Complete confidence. Unrivalled efficiency. Ultimate performance.**

Only SCIEX offers triple quads equipped with Linear Accelerator™ trap technology. The QTRAP 4500 delivers up to a 100-fold increase in full scan MS/MS sensitivity enabling powerful workflows that will give you a new level of confidence in your data.

- Unique scan functionality available only on the QTRAP, allows you to see beyond the matrix to more accurately detect, quantify, and confirm your compounds
- Acquire a complete MS/MS spectrum to accompany your MRM quantitation for every compound detected in your samples and cross reference with an integrated library for ultimate confirmation
- Screen for more compounds in each analysis, without compromising data quality for higher throughput

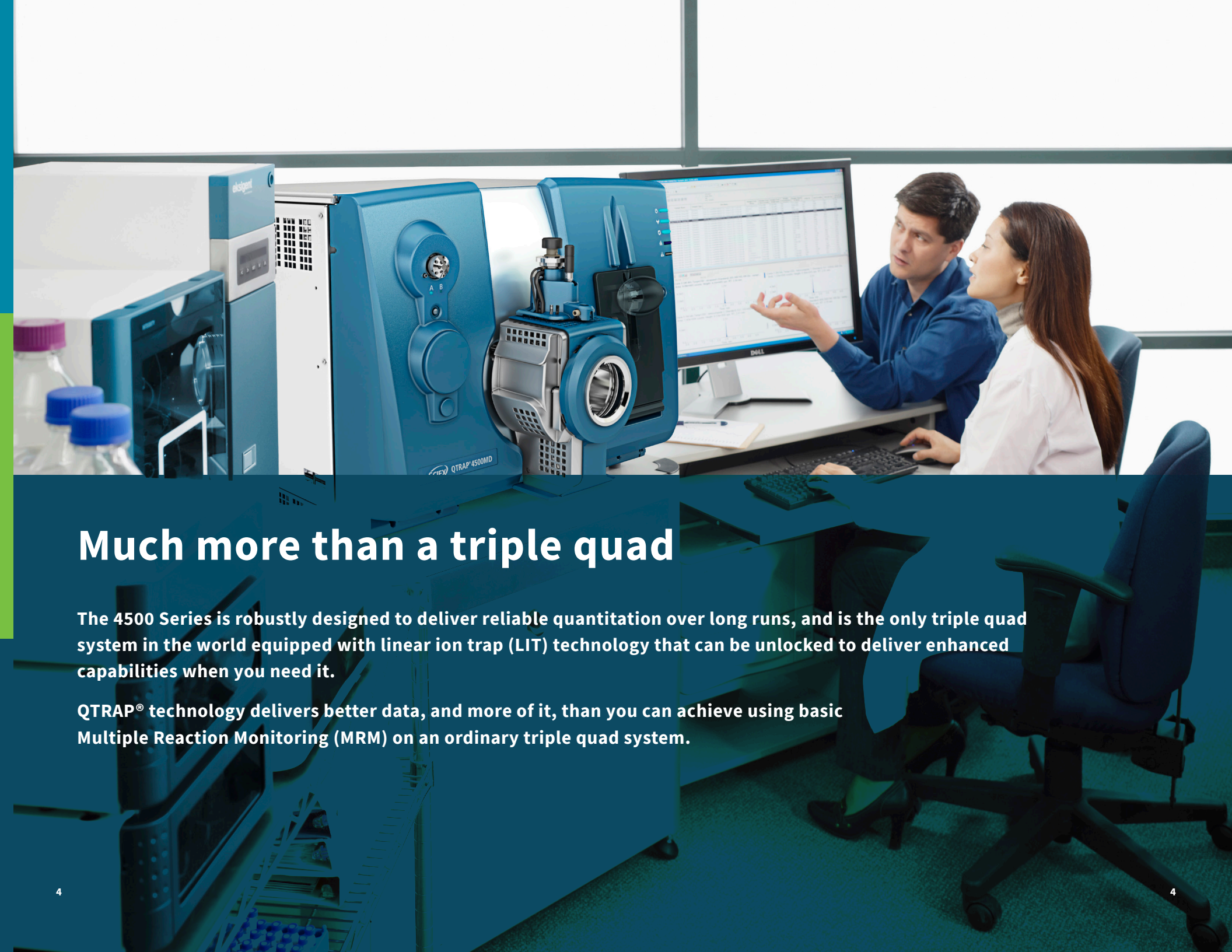

## Much more than a triple quad

The 4500 Series is robustly designed to deliver reliable quantitation over long runs, and is the only triple quad system in the world equipped with linear ion trap (LIT) technology that can be unlocked to deliver enhanced capabilities when you need it.

QTRAP® technology delivers better data, and more of it, than you can achieve using basic Multiple Reaction Monitoring (MRM) on an ordinary triple quad system.

# Definitive quantitation and **so much more**

## Diversity delivered

With the quantitative performance of a triple quad system and additional enhanced scan functionality of QTRAP®, you are able to develop new methods and improve results for your existing workflows.

## See more clearly beyond the matrix

When your analysis suffers from matrix effects and you're concerned about the accuracy of your MRM quantitation, QTRAP technology can reduce the worry. The integrated linear ion trap (LIT) enables more accurate detection, quantification, and confirmation of your compounds – without added laborious or time consuming sample prep.

## More confidently identify your compounds

For borderline MRM ion ratios, resulting in ambiguous identification, there is a solution. The enhanced product ion (EPI) functionality of QTRAP allows you to acquire a complete MS/MS spectrum to accompany your MRM quantitation for every compound detected in your samples. Cross reference this 'compound fingerprint' with an integrated library, and deliver ultimate confirmation and report your analysis without doubt.

## More compounds and more samples

If your workload increases, but your time and resources don't, QTRAP delivers more results in every run. The unique ability to capture MRM and enhanced product ion confirmation scans in one injection, without the need for long and inefficient chromatography, enables reliable screening for more compounds in each analysis, without compromising data quality. This all leads to better throughput, without investing more time and resources.

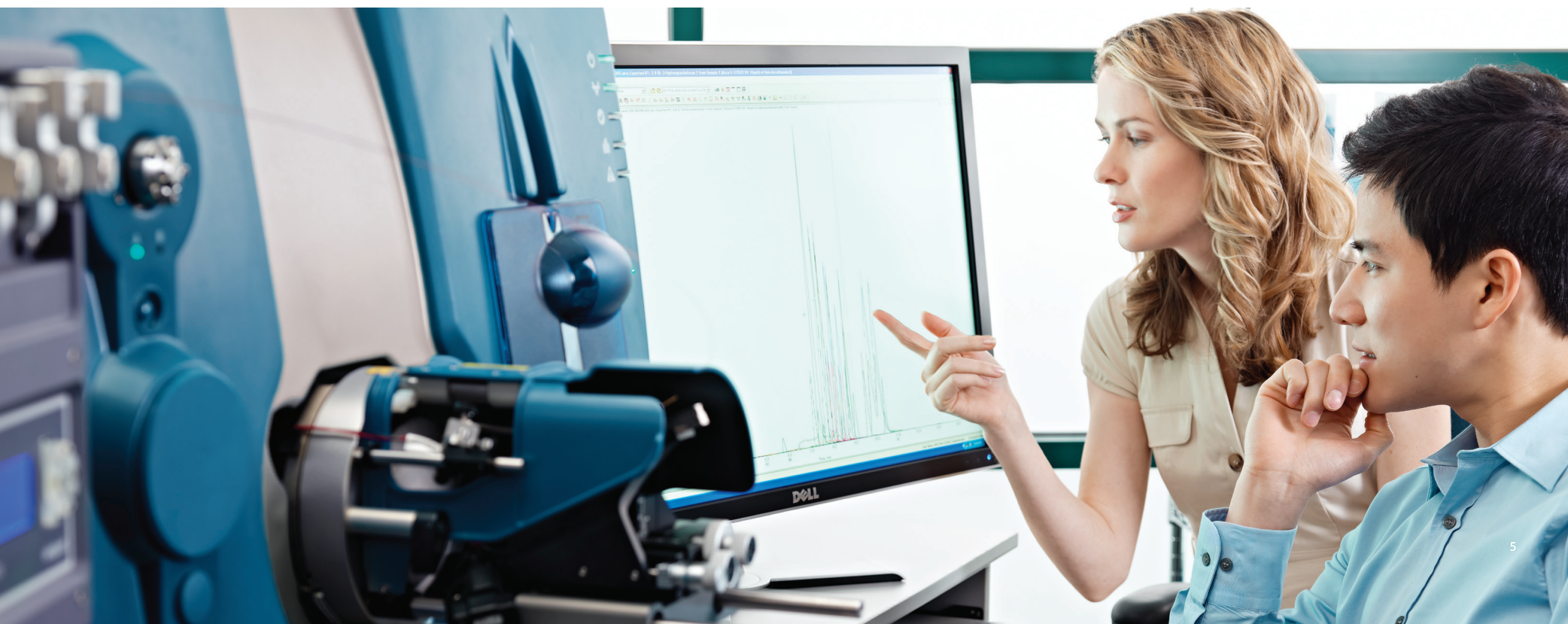

# The future path of LC-MS/MS quantitation

**The SCIEX 4500 Series brings together the latest hardware from the world's best selling triple quadrupole family, and adds next-generation, ultra-fast and sensitive Linear Accelerator™ trap functionality. Delivering unmatched quantitative and qualitative analysis, the 4500 Series enables productive, time-saving workflows unachievable with other mass spectrometry systems.**

## Fast eQ™ electronics for fast LC

Next-generation eQ electronics produce polarity switching in 50 ms and scan speeds of 20,000 Da/s. Now, compounds with vastly different functional groups can be measured in a single pass. The new electronics also improve ion containment for better sensitivity and superior detector performance. Ultra-fast and ultra-stable instrumentation means you get the most out of your standard or fast LC to save time and accelerate your research.

## Patented QJet® ion guide

Optimized design yields better ion containment and operates at high pressure. This provides better collisional focusing to enhance ion transmission for improved sensitivity. The new design also lets the turbopump run cooler and in its ideal operating range.

## AcQuRate™ pulse counting detector

The AcQuRate pulse counting detector combined with a pulse overlap correction algorithm, enables more accurate and precise ion detection over a wide dynamic range. Continuous operation at maximum gain drives the detector into the digital domain, simplifying the elimination of electronic noise and guaranteeing maximum sensitivity with unparalleled accuracy and precision.

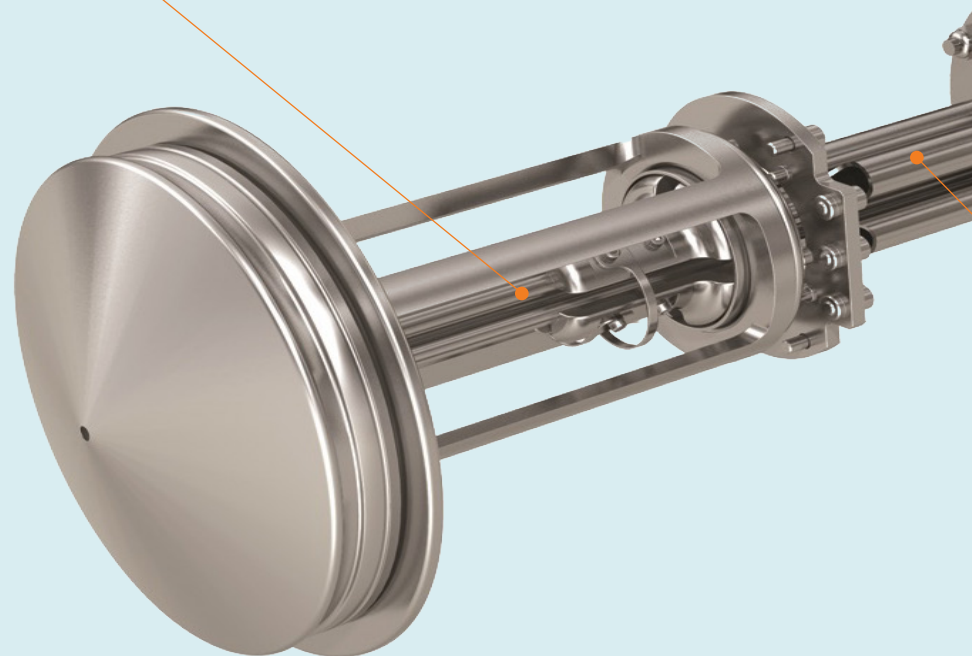

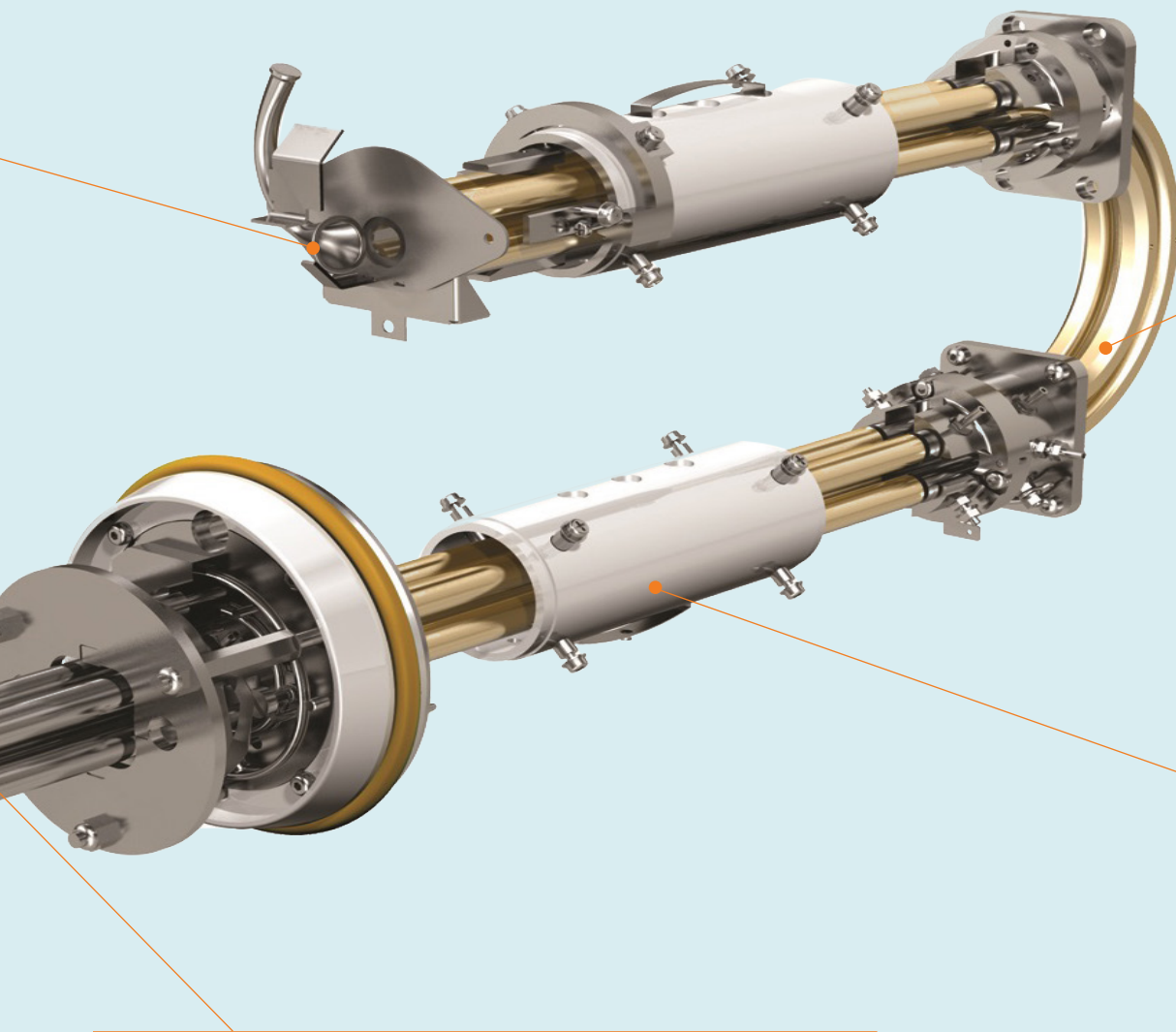

### Patented Curved LINAC® collision cell

The Curved LINAC high-pressure collision cell accelerates ions through the cell to increase speed of analysis and eliminate cross-talk. Improvements to the acclaimed LINAC collision cell result in shorter transit times across the cell, making the Curved LINAC cell an ideal match for UHPLC and high throughput analysis focused on hundreds of compounds. True collision-induced fragmentation with the Curved LINAC collision cell generates reliable, information-rich, library-searchable MS/MS spectra time after time.

### Integrated QTRAP® technology

LINAC® collision cell technology in the Q3 linear ion trap greatly improves extraction efficiency to yield up to a 100X gain in sensitivity under ion trap scan modes. Take full advantage of the 20,000 Da/s scan speeds with full scan linear ion trap sensitivity – 100X more sensitive than triple quad full scan experiments for greater confidence in qualitative workflows. Improved excitation efficiencies and reduced ion cooling and fragmentation times produce superior MS<sup>3</sup> qualitative results and provide unprecedented selectivity for the most challenging analytical assays.

### Proven Q0 high-pressure cell

The high pressure collisional focusing technology maximizes transmission of ions for superior sensitivity.

Ions can be accumulated in the Q0 region while the Linear Accelerator™ trap is performing MS/MS and MS<sup>3</sup> scans. This yields superior sensitivity in ion trap mode, which can be extremely important for fast UHPLC applications where time and duty cycle are condensed.

# Robustness and performance for any application

## Contaminant analysis

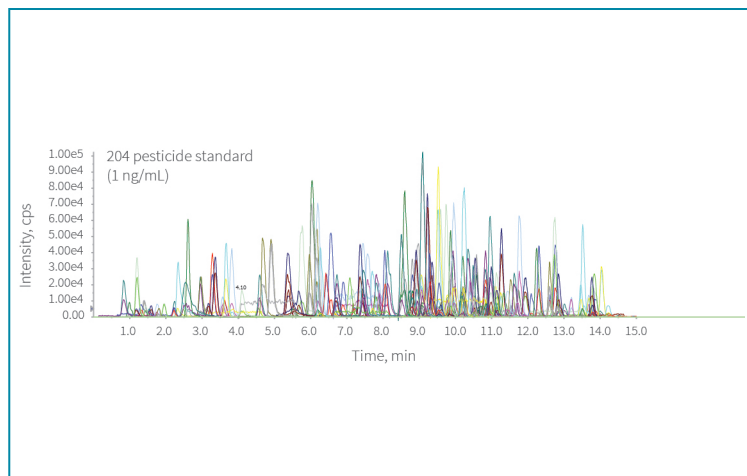

With dwell times as low as 1ms, the 4500 Series is ideally suited for multi component contaminant analysis as these data demonstrate with the detection of over 200 pesticides at 1ng/mL. The faster electronics and the intelligent *Scheduled MRM™* (sMRM), permits the screening of hundreds of pesticides in a UHPLC time scale.

## Drug monitoring research

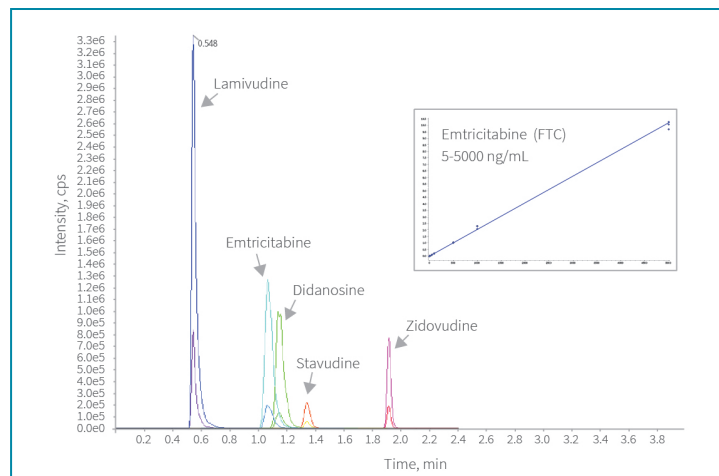

Superior quantitative performance for sensitive, accurate, and reliable analysis in antiretroviral drug research.

## Drug discovery and development

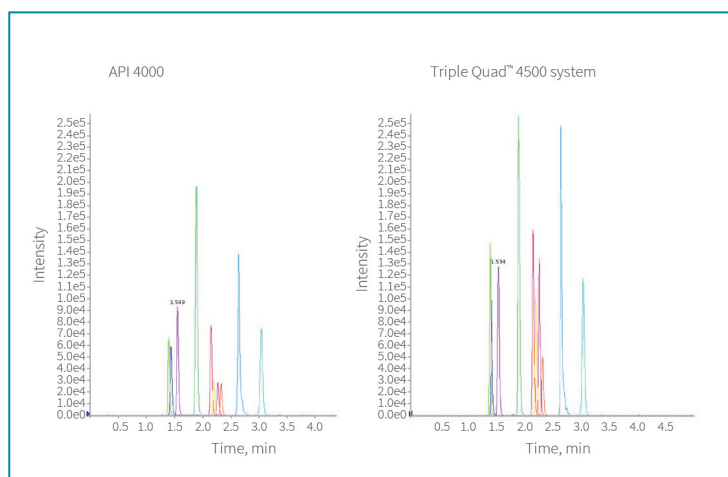

Without compromising sensitivity, the SCIEX QTRAP® 4500 System has improved in every category vs. the API 4000™ including dynamic range, scan speed and footprint.

## Peptide quantitation

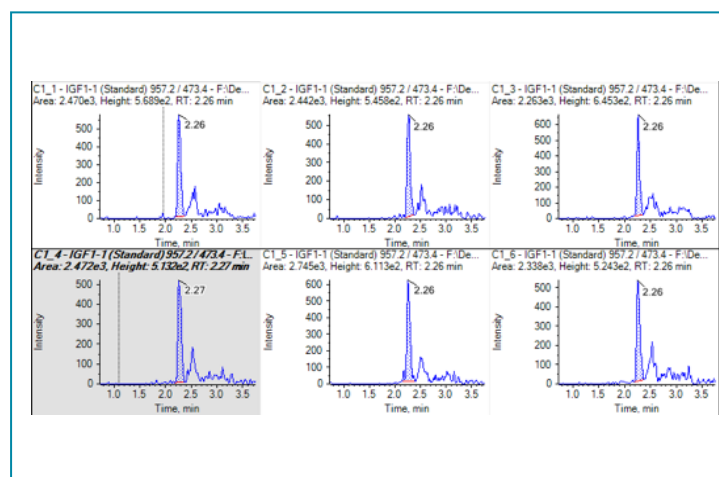

IGF1 quantitation in rat serum achieved a LLOQ of 10 ng/mL. The assay accuracy is 91-106%. To evaluate the assay reproducibility especially for the low concentration samples, six individually prepared samples with IGF1 at 10 ng/mL were analyzed and reported with CV% as 5.57%.



# QTRAP<sup>®</sup> technology – unmatched versatility and confidence

## MRM<sup>3</sup> – enhanced selectivity

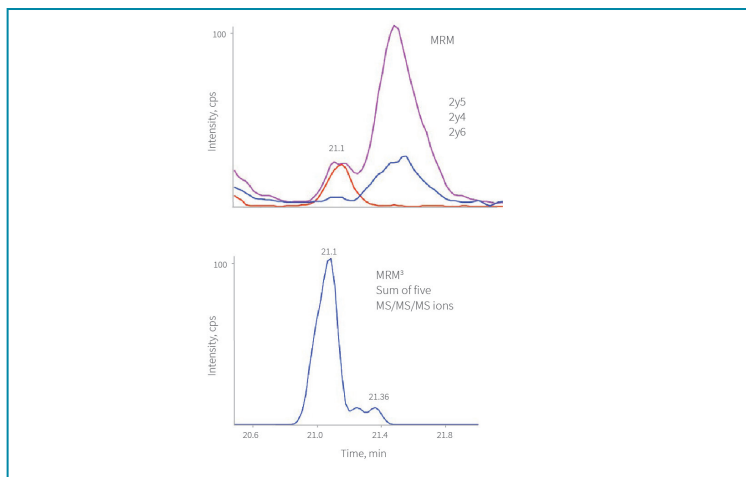

Quantitation of tryptic peptides in a complex matrix. Higher selectivity workflows such as MRM<sup>3</sup> (bottom) can provide additional specificity for low level detection of compounds when high background or interferences render MRM workflows ineffective (top).

## High confidence library searching capabilities

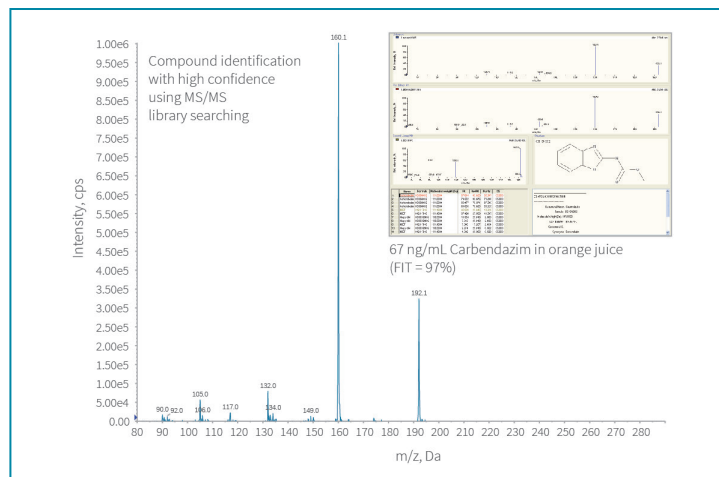

Combining intelligent peak detection with the ability to trap and scan out ions on a UHPLC time scale, creates a potent solution for detecting unexpected contaminants. Add to this a single library of thousands of QTRAP spectra for library matching, and contaminants at the lowest levels can be confidently identified.

## Reactive metabolite screening

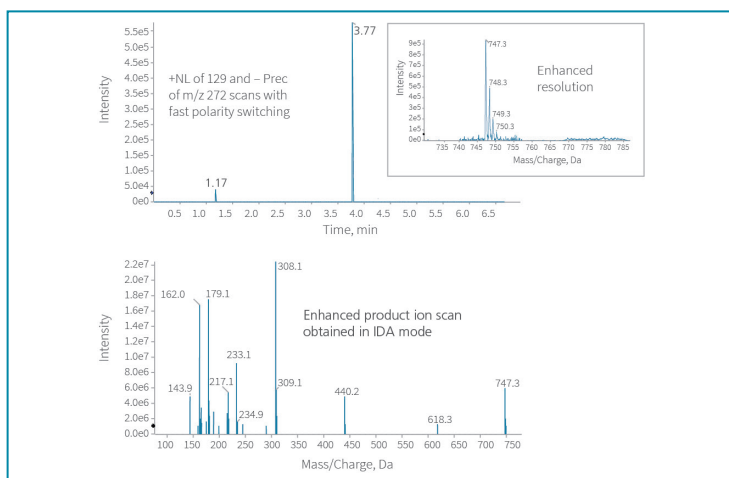

Troglitazone GSH adduct was detected using complimentary positive neutral loss and negative precursor ion scans, combined with Information Dependent Acquisition (IDA) linear ion trap scans. This unique workflow results in the comprehensive detection and characterization of GSH adducts in a single injection.

## Qual-Quant: detection and confirmation

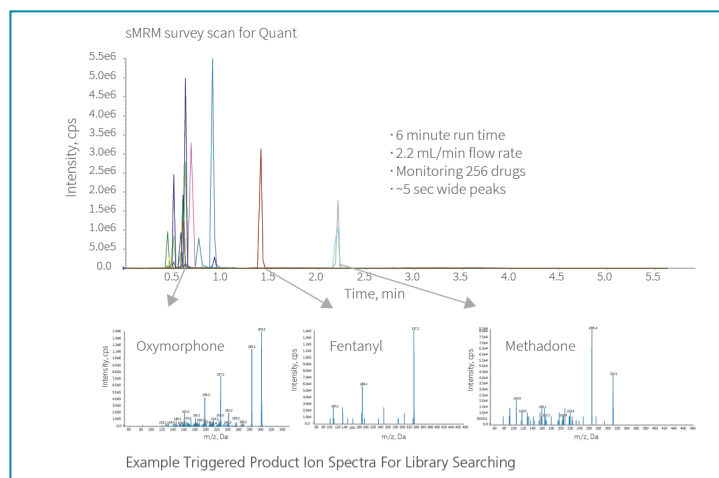

The QTRAP 4500 system allows *Scheduled* MRM<sup>™</sup> (sMRM) to trigger high quality, full scan product ion spectra for use in library searching. With highly sensitive Triple Trap<sup>™</sup> scanning it is possible to confidently identify compounds at up to 100X lower concentrations than triple quadrupole full scans.



### Drive productivity

The **Turbo V™ ion source** provides high-sensitivity analysis over a wide range of flow rates with quick-change APCI and TurbolonSpray® probes. From 50 µL/min to 3 mL/min, the Turbo V source is the perfect match for narrow bore, standard bore and UHPLC flow rates, delivering unprecedented desolvation and stability for even the toughest high-flow applications.



### Ultimate sensitivity and simplicity

The **patented QJet® ion guide** improves ion containment and operates at high pressure, providing better collisional focusing to enhance ion transmission for ultimate sensitivity. The proven design also reduces the gas load, allowing the turbopump to run cooler in its ideal operating range. It all adds up to our most reliable system – and with tool-free maintenance, clean-up is simple and straightforward.

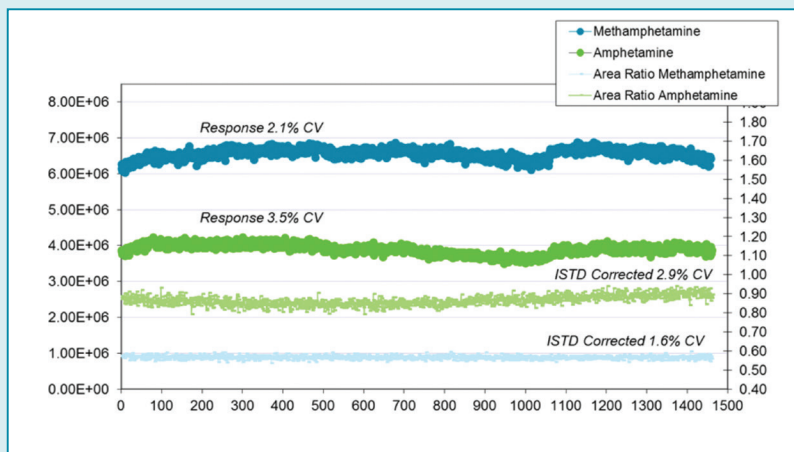

The excellent reproducibility for the peak area ratio of Methamphetamine and Amphetamine in human plasma shows the stability of the AcQuRate™ pulse counting detector for consistent quantification

# Boost your mass spectrometry experiments with SCIEX software

Take full advantage of all the speed and power of the 4500 Series. Powerful, workflow-driven software ties everything together efficiency, throughput, and productivity. Industry-standard Analyst® Software utilizes the intelligent *Scheduled* MRM™ algorithm to make the method setup of over 1000 analytes in a single LC analysis straightforward and simple while SCIEX OS Software generates exceptional quantitative and brilliant qualitative results.

## Save time, without compromising



### Instrument control, analysis, and reporting

Analyst Software provides state-of-the-art functionality for instrument control, data analysis, and reporting. The latest version builds on this legacy by providing new features that enhance both performance and ease of use.



### Boosting qualitative and quantitative workflows

SCIEX OS Software is an easy-to-learn and user-friendly software platform that handles all your qualitative and quantitative analysis tasks. Automation tools simplify batch handling and cut down on the hassle of manual interaction and optimization. New proprietary algorithms save a significant amount of time on data review and improve your confidence in results.



### Complete metabolite coverage

LightSight® Software simplifies analysis of complete metabolite coverage. Create expert-level acquisition methods in just a few simple steps using the automated method development tool. Alternatively, take advantage of customized glutathione screening to quickly identify potential reactive metabolites and significantly increase metabolite detection with targeted methods.

# SCIEX Now™ Support Network

## The destination for all your support needs

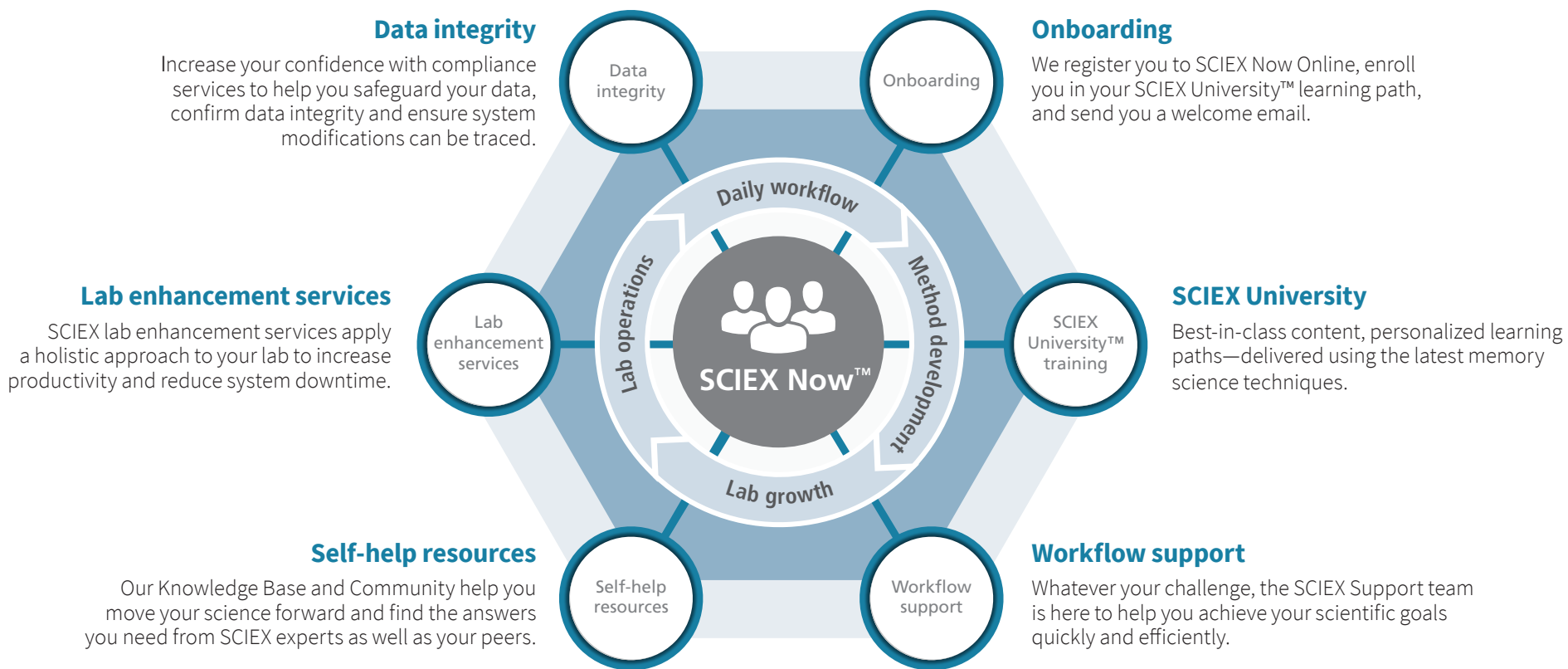

**Start your path to success now: [sciex.com/sciexnow](https://sciex.com/sciexnow)**

The SCIEX clinical diagnostic portfolio is For In Vitro Diagnostic Use. Rx Only. Product(s) not available in all countries. For information on availability, please contact your local sales representative or refer to <https://sciex.com/diagnostics>. All other products are For Research Use Only. Not for use in Diagnostic Procedures. Trademarks and/or registered trademarks mentioned herein are the property of AB Sciex Pte. Ltd. or their respective owners in the United States and/or certain other countries. © 2019 DH Tech. Dev. Pte. Ltd.

RUO-MKT-03-0137-E

**Headquarters**  
500 Old Connecticut Path  
Framingham, MA 01701 USA  
Phone 508-383-7700  
[sciex.com](https://sciex.com)

**International Sales**  
For our office locations please call the division headquarters or refer to our website at [sciex.com/offices](https://sciex.com/offices)

